

Article number: 0106053

Description: Retaining ring JV 36

Measures

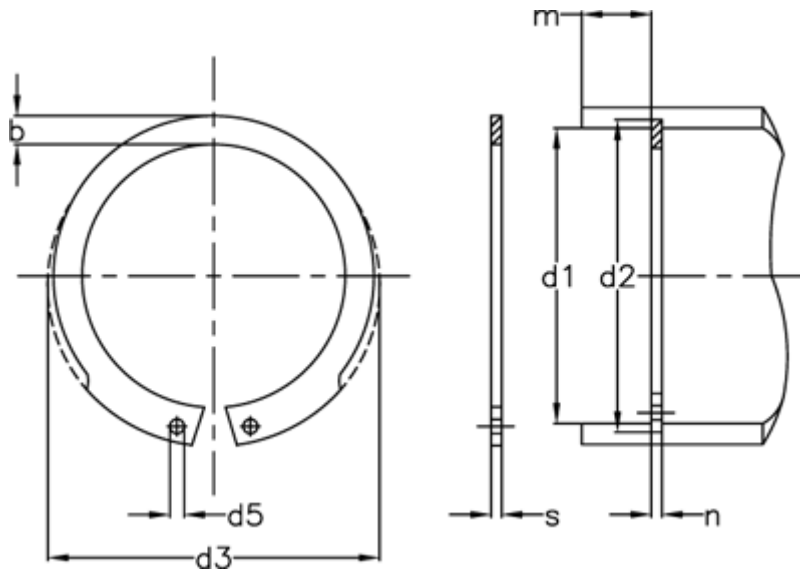

AN mm ²	= 58	FRg kN	= 6.6	tol	= 0.1
b	= 3.6	FR kN	= 27.5	tol	= -0.06
d1	= 36	g	= 1.5	tol	= +0,50-0,25
d2	= 38.0	K kN-mm	= 51.5	tol	= +0,25
d3	= 38.8	m min	= 1.60	Tong	= ZGJ-1
d5 min	= 1.7	Nominal drive	= 3.0	Weight kg/1000	= 3.23
Description	= JV 36	s	= 1.50		
FN kN	= 9.70	t	= 1.00		